

DATA MINING

LECTURE 1

Introduction

What is data mining?

- After years of data mining there is still no unique answer to this question.



- A tentative definition:

Data mining is the use of **efficient** techniques for the analysis of **very large** collections of data and the extraction of **useful** and possibly **unexpected** patterns in data.



Why do we need data mining?

- **Really, really huge amounts of raw data!!**
 - In the digital age, TB of data is generated by the second
 - Mobile devices, digital photographs, web documents.
 - Facebook updates, Tweets, Blogs, User-generated content
 - Transactions, sensor data, surveillance data
 - Queries, clicks, browsing
 - Cheap storage has made possible to maintain this data
- **Need to analyze the raw data to extract knowledge**

Why do we need data mining?

- “The data is the computer”
 - Large amounts of data can be more powerful than complex algorithms and models
 - Google has solved many Natural Language Processing problems, simply by looking at the data
 - Example: misspellings, synonyms
 - Data is power!
 - Today, the collected data is one of the biggest assets of an online company
 - Query logs of Google
 - The friendship and updates of Facebook
 - Tweets and follows of Twitter
 - Amazon transactions
 - We need a way to harness the collective intelligence

The data is also very **complex**

- Multiple **types** of data: tables, time series, images, graphs, etc
- **Spatial** and **temporal** aspects
- **Interconnected** data of different types:
 - From the mobile phone we can collect, location of the user, friendship information, check-ins to venues, opinions through twitter, images through cameras, queries to search engines

Example: transaction data

- Billions of real-life customers:
 - WALMART: 20M transactions per day
 - AT&T 300 M calls per day
 - Credit card companies: billions of transactions per day.
- The point cards allow companies to collect information about specific users

Example: document data

- Web as a document repository: estimated 50 billions of web pages
- Wikipedia: 4 million articles (and counting)
- Online news portals: steady stream of 100's of new articles every day
- Twitter: ~300 million tweets every day

Example: network data

- Web: 50 billion pages linked via hyperlinks
- Facebook: 500 million users
- Twitter: 300 million users
- Instant messenger: ~1 billion users
- Blogs: 250 million blogs worldwide, presidential candidates run blogs

Example: genomic sequences

- <http://www.1000genomes.org/page.php>
- Full sequence of 1000 individuals
- 3×10^9 nucleotides per person $\rightarrow 3 \times 10^{12}$ nucleotides
- Lots more data in fact: medical history of the persons, gene expression data

Example: environmental data

- Climate data (just an example)

<http://www.ncdc.gov/oa/climate/ghcn-monthly/index.php>

- “a database of temperature, precipitation and pressure records managed by the National Climatic Data Center, Arizona State University and the Carbon Dioxide Information Analysis Center”
- “6000 temperature stations, 7500 precipitation stations, 2000 pressure stations”
 - **Spatiotemporal** data

Behavioral data

- Mobile phones today record a large amount of information about the user behavior
 - GPS records position
 - Camera produces images
 - Communication via phone and SMS
 - Text via facebook updates
 - Association with entities via check-ins
- Amazon collects all the items that you browsed, placed into your basket, read reviews about, purchased.
- Google and Bing record all your browsing activity via toolbar plugins. They also record the queries you asked, the pages you saw and the clicks you did.
- Data collected for millions of users on a daily basis

So, what is Data?

- Collection of data **objects** and their **attributes**
- An attribute is a property or characteristic of an object
 - Examples: eye color of a person, temperature, etc.
 - Attribute is also known as **variable**, **field**, **characteristic**, or **feature**
- A collection of attributes describe an object
 - Object is also known as **record**, **point**, **case**, **sample**, **entity**, or **instance**

Objects

Attributes

<i>Tid</i>	Refund	Marital Status	Taxable Income	Cheat
1	Yes	Single	125K	No
2	No	Married	100K	No
3	No	Single	70K	No
4	Yes	Married	120K	No
5	No	Divorced	95K	Yes
6	No	Married	60K	No
7	Yes	Divorced	220K	No
8	No	Single	85K	Yes
9	No	Married	75K	No
10	No	Single	90K	Yes

Size: Number of objects

Dimensionality: Number of attributes

Sparsity: Number of populated object-attribute pairs

Types of Attributes

- There are different types of attributes
 - **Categorical**
 - Examples: eye color, zip codes, words, rankings (e.g, good, fair, bad), height in {tall, medium, short}
 - **Nominal** (no order or comparison) vs **Ordinal** (order but not comparable)
 - **Numeric**
 - Examples: dates, temperature, time, length, value, count.
 - **Discrete** (counts) vs **Continuous** (temperature)
 - Special case: **Binary** attributes (yes/no, exists/not exists)

Numeric Record Data

- If data objects have the same **fixed set** of **numeric attributes**, then the data objects can be thought of as **points** in a multi-dimensional space, where each **dimension** represents a distinct attribute
- Such data set can be represented by an **n-by-d data matrix**, where there are **n** rows, one for each object, and **d** columns, one for each attribute

Projection of x Load	Projection of y load	Distance	Load	Thickness
10.23	5.27	15.22	2.7	1.2
12.65	6.25	16.22	2.2	1.1

Categorical Data

- Data that consists of a collection of records, each of which consists of a **fixed set** of **categorical** attributes

<i>Tid</i>	Refund	Marital Status	Taxable Income	Cheat
1	Yes	Single	High	No
2	No	Married	Medium	No
3	No	Single	Low	No
4	Yes	Married	High	No
5	No	Divorced	Medium	Yes
6	No	Married	Low	No
7	Yes	Divorced	High	No
8	No	Single	Medium	Yes
9	No	Married	Medium	No
10	No	Single	Medium	Yes

Document Data

- Each document becomes a `term' vector,
 - each term is a component (attribute) of the vector,
 - the value of each component is the number of times the corresponding term occurs in the document.
 - **Bag-of-words** representation – no ordering

	team	coach	play	ball	score	game	win	lost	timeout	season
Document 1	3	0	5	0	2	6	0	2	0	2
Document 2	0	7	0	2	1	0	0	3	0	0
Document 3	0	1	0	0	1	2	2	0	3	0

Transaction Data

- Each record (transaction) is a **set of items**.

<i>TID</i>	<i>Items</i>
1	Bread, Coke, Milk
2	Beer, Bread
3	Beer, Coke, Diaper, Milk
4	Beer, Bread, Diaper, Milk
5	Coke, Diaper, Milk

- A set of items can also be represented as a **binary vector**, where each attribute is an item.
- A document can also be represented as a **set of words** (no counts)

Sparsity: average number of products bought by a customer

Ordered Data

- Genomic **sequence** data

```
GGTTC CGCCTTCAGCCCCGCGCC  
CGCAGGGCCCGCCCCGCGCCGTC  
GAGAAGGGCCCGCCTGGCGGGCG  
GGGGGAGGCGGGGCCGCCCGAGC  
CCAACCGAGTCCGACCAGGTGCC  
CCCTCTGCTCGGCCTAGACCTGA  
GCTCATTAGGCGGCAGCGGACAG  
GCCAAGTAGAACACGCGAAGCGC  
TGGGCTGCCTGCTGCGACCAGGG
```

- Data is a long **ordered** string

Ordered Data

- Time series
 - Sequence of ordered (over “time”) numeric values.



Graph Data

- Examples: Web graph and HTML Links

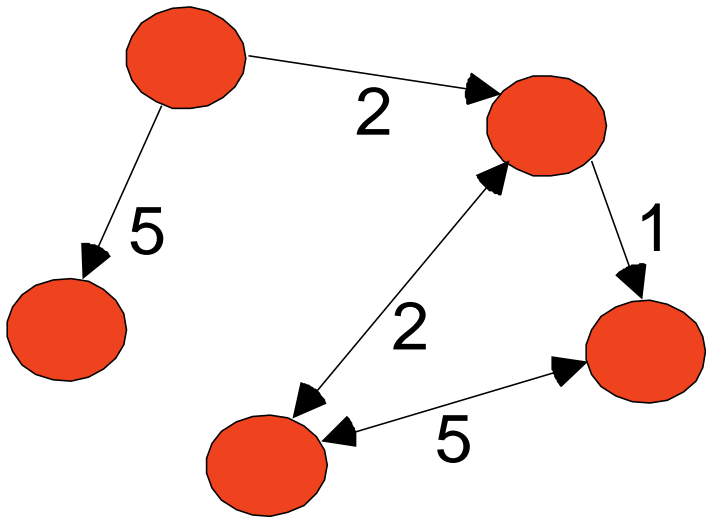

```
<a href="papers/papers.html#bbbb">  
Data Mining </a>
```

```
<li>
```

```
<a href="papers/papers.html#aaaa">  
Graph Partitioning </a>
```

```
<li>
```

```
<a href="papers/papers.html#aaaa">  
Parallel Solution of Sparse Linear System of Equations </a>
```

```
<li>
```

```
<a href="papers/papers.html#ffff">  
N-Body Computation and Dense Linear System Solvers
```

Types of data

- **Numeric data:** Each object is a point in a multidimensional space
- **Categorical data:** Each object is a vector of categorical values
- **Set data:** Each object is a set of values (with or without counts)
 - Sets can also be represented as binary vectors, or vectors of counts
- **Ordered sequences:** Each object is an ordered sequence of values.
- **Graph data**

What can you do with the data?

- Suppose that you are the owner of a supermarket and you have collected billions of **market basket** data. What information would you extract from it and how would you use it?

<i>TID</i>	<i>Items</i>
1	Bread, Coke, Milk
2	Beer, Bread
3	Beer, Coke, Diaper, Milk
4	Beer, Bread, Diaper, Milk
5	Coke, Diaper, Milk

Product placement

Catalog creation

Recommendations

- What if this was an online store?

What can you do with the data?

- Suppose you are a search engine and you have a **toolbar log** consisting of
 - pages browsed,
 - queries,
 - pages clicked,
 - ads clicked

Ad click prediction

Query reformulations

each with a **user id** and a **timestamp**. What information would you like to get out of the data?

What can you do with the data?

- Suppose you are biologist who has **microarray expression data**: thousands of genes, and their expression values over thousands of different settings (e.g. tissues). What information would you like to get out of your data?

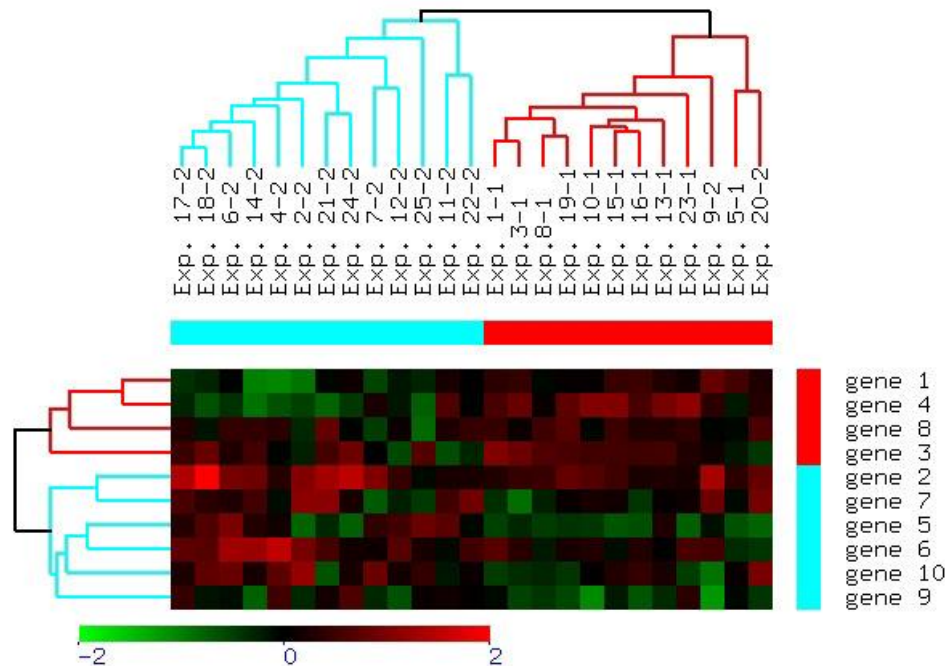

Groups of genes and tissues

What can you do with the data?

- Suppose you are a stock broker and you observe the fluctuations of multiple stocks over time. What information would you like to get out of your data?



What can you do with the data?

- You are the owner of a social network, and you have full access to the social graph, what kind of information do you want to get out of your graph?
 - Who is the most important node in the graph?
 - What is the shortest path between two nodes?
 - How many friends two nodes have in common?
 - How does information spread on the network?

Why data mining?

- **Commercial** point of view
 - Data has become the key competitive advantage of companies
 - Examples: Facebook, Google, Amazon
 - Being able to extract useful information out of the data is key for exploiting them commercially.
- **Scientific** point of view
 - Scientists are at an unprecedented position where they can collect TB of information
 - Examples: Sensor data, astronomy data, social network data, gene data
 - We need the tools to analyze such data to get a better understanding of the world and advance science
- **Scale** (in data **size** and feature **dimension**)
 - Why not use traditional analytic methods?
 - Enormity of data, **curse of dimensionality**
 - The amount and the complexity of data does not allow for manual processing of the data. We need automated techniques.

Why data mining?

There is also [this](#) reason...

"The success of companies like Google, Facebook, Amazon, and Netflix, not to mention Wall Street firms and industries from manufacturing and retail to healthcare, is increasingly driven by better tools for extracting meaning from very large quantities of data. 'Data Scientist' is now the hottest job title in Silicon Valley." – Tim O'Reilly

Data Scientist: The Sexiest Job of the 21st Century

by Thomas H. Davenport and D.J. Patil

Comments (87)



Artwork: Tamar Cohen, Andrew J Buboltz, 2011, silk screen on a page from a high school yearbook. 6.5" x 4.5"

RELATED

Executive Summary

ALSO AVAILABLE

- Buy PDF

What is Data Mining again?

- “Data mining is the analysis of (often large) observational data sets to find **unsuspected relationships** and to **summarize** the data in novel ways that are both **understandable and useful** to the data analyst” (Hand, Mannila, Smyth)
- “Data mining is the discovery of **models** for data” (Rajaraman, Ullman)
 - We can have the following types of models
 - Models that **explain** the data (e.g., a single function)
 - Models that **predict** the future data instances.
 - Models that **summarize** the data
 - Models the **extract** the most prominent **features** of the data.

What is data mining again?

- The **industry** point of view: The analysis of **huge amounts of data** for extracting useful and actionable information, which is then integrated into **production** systems in the form of new features of products
 - **Data Scientists** should be good at **data analysis, math, statistics**, but also be able to **code** with huge amounts of data and use the extracted information to **build** products.

What can we do with data mining?

- Some examples:
 - Frequent itemsets and Association Rules extraction
 - Coverage
 - Clustering
 - Classification
 - Ranking
 - Exploratory analysis

Frequent Itemsets and Association Rules

- Given a set of records each of which contain some number of items from a given collection;
 - Identify sets of items (**itemsets**) occurring frequently together
 - Produce **dependency rules** which will predict occurrence of an item based on occurrences of other items.

<i>TID</i>	<i>Items</i>
1	Bread, Coke, Milk
2	Beer, Bread
3	Beer, Coke, Diaper, Milk
4	Beer, Bread, Diaper, Milk
5	Coke, Diaper, Milk

Itemsets Discovered:

{Milk,Coke}
{Diaper, Milk}

Rules Discovered:

{Milk} --> {Coke}
{Diaper, Milk} --> {Beer}

Frequent Itemsets: Applications

- Text mining: finding associated phrases in text
 - There are lots of documents that contain the phrases “association rules”, “data mining” and “efficient algorithm”
- Recommendations:
 - Users who buy this item often buy this item as well
 - Users who watched James Bond movies, also watched Jason Bourne movies.
 - Recommendations make use of **item and user similarity**

Association Rule Discovery: Application

- Supermarket **shelf management**.
 - Goal: To identify items that are bought together by sufficiently many customers.
 - Approach: Process the point-of-sale data collected with barcode scanners to find dependencies among items.
 - A classic rule --
 - If a customer buys diaper and milk, then he is very likely to buy beer.
 - So, don't be surprised if you find six-packs stacked next to diapers!

Clustering Definition

- Given a set of data points, each having a set of attributes, and a similarity measure among them, find clusters such that
 - Data points in one cluster are more similar to one another.
 - Data points in separate clusters are less similar to one another.
- Similarity Measures?
 - Euclidean Distance if attributes are continuous.
 - Other Problem-specific Measures.

Illustrating Clustering

Euclidean Distance Based Clustering in 3-D space.

Intracluster distances
are minimized

Intercluster distances
are maximized

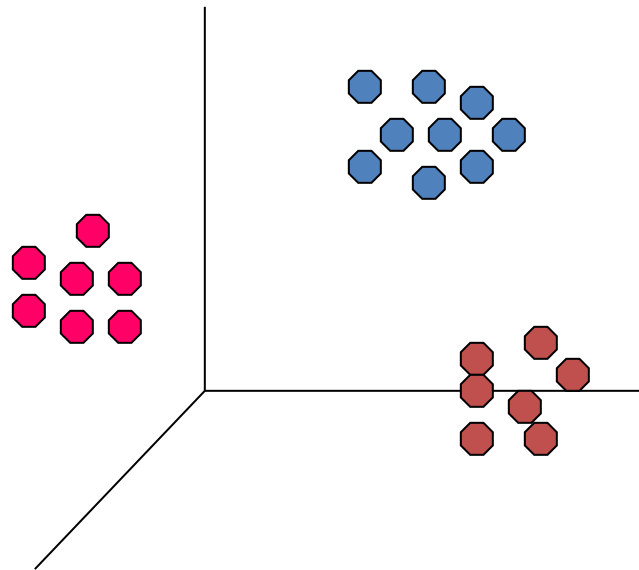

Clustering: Application 1

- Bioinformatics applications:
 - Goal: Group genes and tissues together such that genes are coexpressed on the same tissues

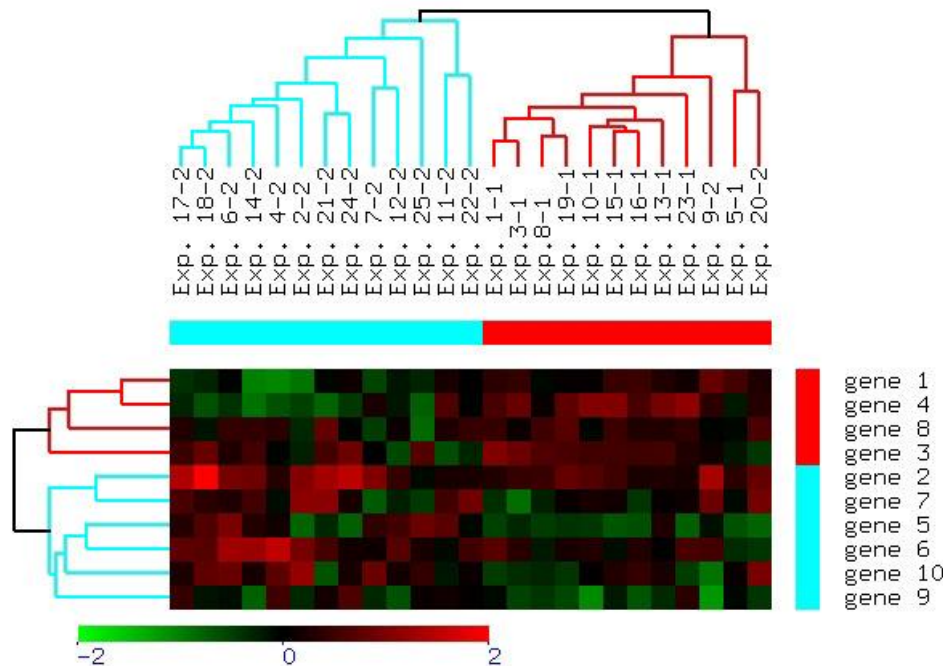

Clustering: Application 2

- Document Clustering:
 - Goal: To find groups of documents that are similar to each other based on the important terms appearing in them.
 - Approach: To identify frequently occurring terms in each document. Form a similarity measure based on the frequencies of different terms. Use it to cluster.
 - Gain: Information Retrieval can utilize the clusters to relate a new document or search term to clustered documents.

Coverage

- Given a set of customers and items and the transaction relationship between the two, select a small set of items that “covers” all users.
 - For each user there is at least one item in the set that the user has bought.
- Application:
 - Create a catalog to send out that has at least one item of interest for every customer.

Classification: Definition

- Given a collection of records (*training set*)
 - Each record contains a set of *attributes*, one of the attributes is the *class*.
- Find a *model* for class attribute as a function of the values of other attributes.
- Goal: previously unseen records should be assigned a class as accurately as possible.
 - A *test set* is used to determine the accuracy of the model. Usually, the given data set is divided into training and test sets, with training set used to build the model and test set used to validate it.

Classification Example

categorical
categorical
continuous
class

<i>Tid</i>	Refund	Marital Status	Taxable Income	Cheat
1	Yes	Single	125K	No
2	No	Married	100K	No
3	No	Single	70K	No
4	Yes	Married	120K	No
5	No	Divorced	95K	Yes
6	No	Married	60K	No
7	Yes	Divorced	220K	No
8	No	Single	85K	Yes
9	No	Married	75K	No
10	No	Single	90K	Yes

Refund	Marital Status	Taxable Income	Cheat
No	Single	75K	?
Yes	Married	50K	?
No	Married	150K	?
Yes	Divorced	90K	?
No	Single	40K	?
No	Married	80K	?

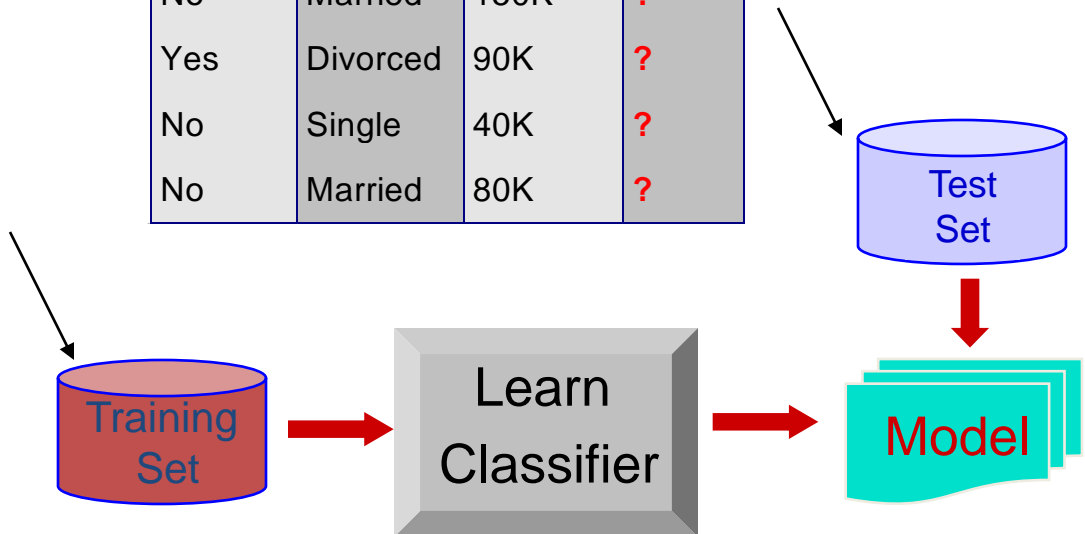

Classification: Application 1

- Ad Click Prediction
 - Goal: Predict if a user that visits a web page will click on a displayed ad. Use it to target users with high click probability.
 - Approach:
 - Collect data for users over a period of time and record who clicks and who does not. The {click, no click} information forms the **class attribute**.
 - Use the history of the user (web pages browsed, queries issued) as the features.
 - Learn a classifier model and test on new users.

Classification: Application 2

- Fraud Detection
 - Goal: Predict fraudulent cases in credit card transactions.
 - Approach:
 - Use credit card transactions and the information on its account-holder as attributes.
 - When does a customer buy, what does he buy, how often he pays on time, etc
 - **Label** past transactions as fraud or fair transactions. This forms the class attribute.
 - Learn a model for the class of the transactions.
 - Use this model to detect fraud by observing credit card transactions on an account.

Network data analysis

- **Link Analysis Ranking:** Given a collection of web pages that are linked to each other, rank the pages according to importance (**authoritativeness**) in the graph
 - Intuition: A page gains authority if it is linked to by another page.
- Application: When retrieving pages, the authoritativeness is factored in the ranking.

Network data analysis

- Given a social network can you predict which individuals will connect in the future?
 - Triadic closure principle: Links are created in a way that usually closes a triangle
 - If both Bob and Charlie know Alice, then they are likely to meet at some point.
- Application: Friend/Connection **recommendations** in social networks

Exploratory Analysis

- Trying to understand the data as a **physical phenomenon**, and describe them with simple metrics
 - What does the web graph look like?
 - How often do people repeat the same query?
 - Are friends in facebook also friends in twitter?
- The important thing is to find the right **metrics** and ask the right **questions**
- It helps our understanding of the world, and can lead to **models** of the phenomena we observe.

Exploratory Analysis: The Web

- What is the structure and the properties of the web?

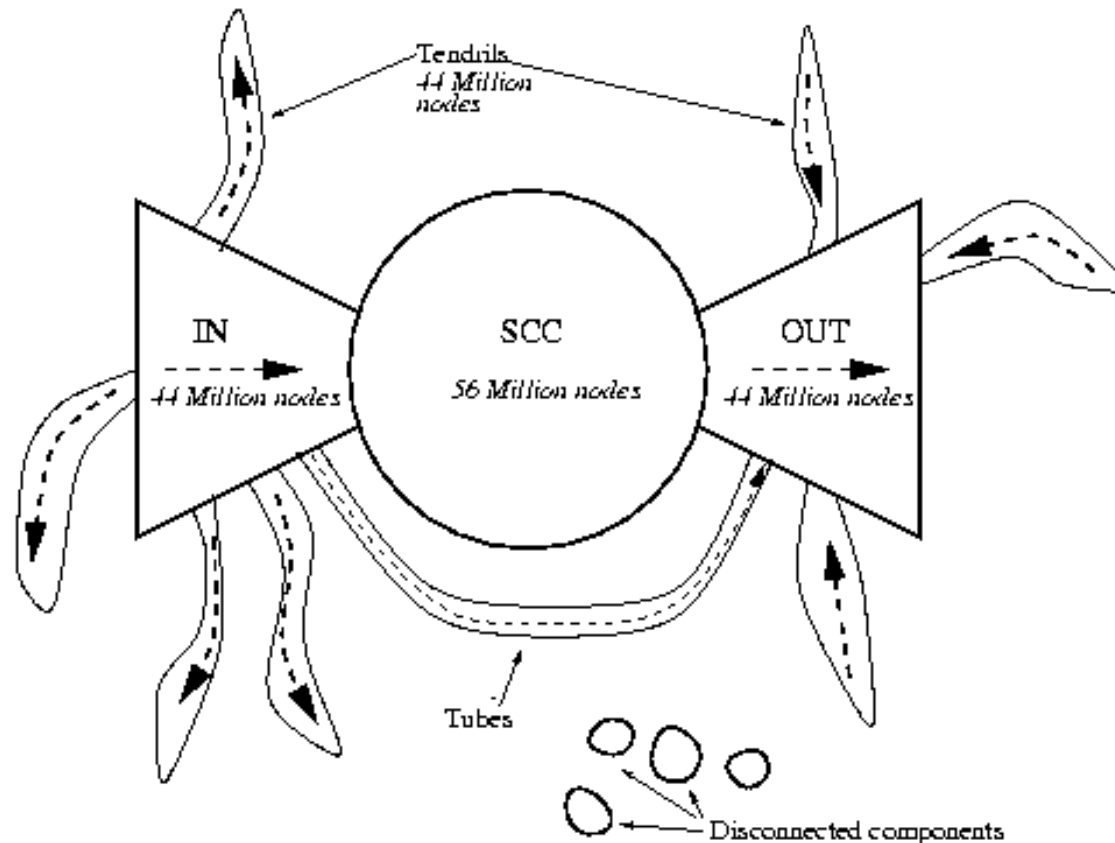

Exploratory Analysis: The Web

- What is the distribution of the incoming links?

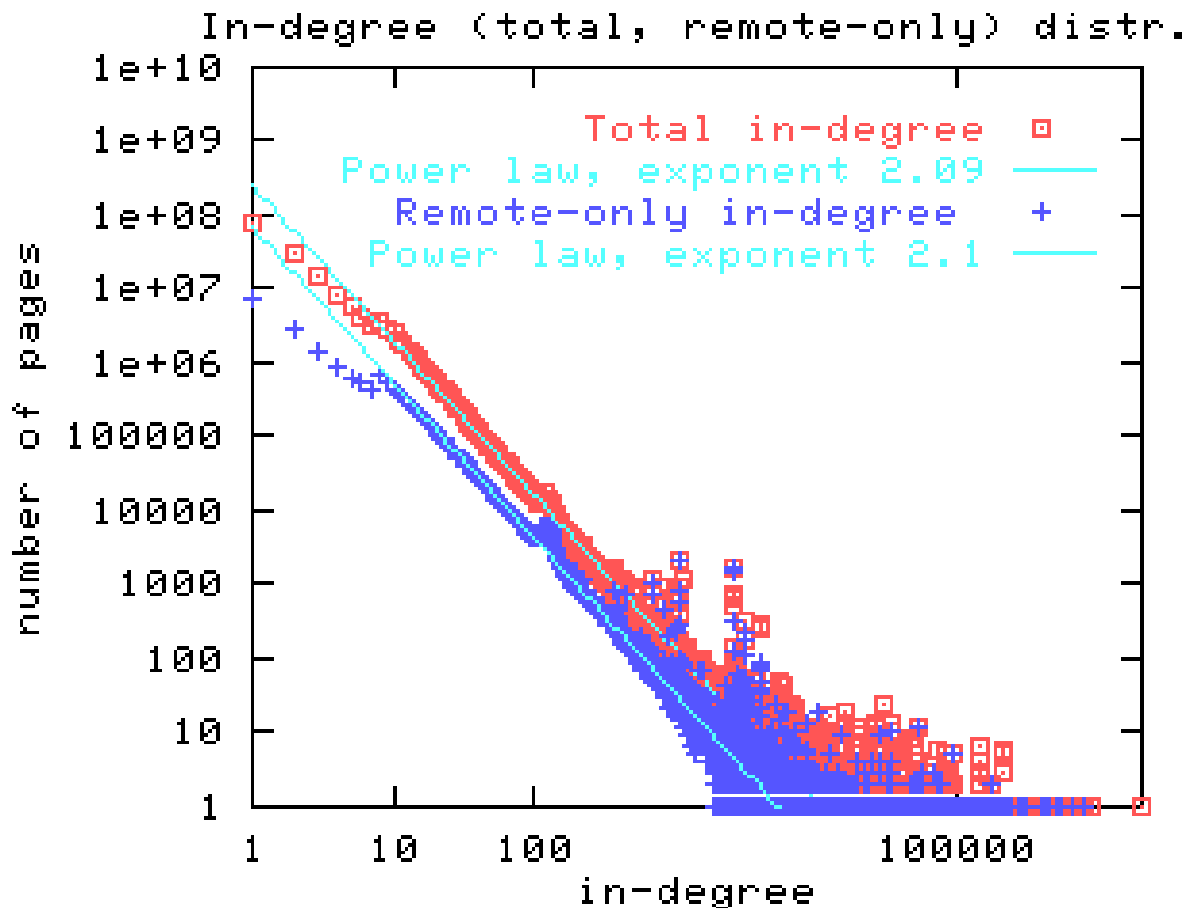

Connections of Data Mining with other areas

- Draws ideas from machine learning/AI, pattern recognition, statistics, and database systems
- Traditional Techniques may be unsuitable due to
 - Enormity of data
 - High dimensionality of data
 - Heterogeneous, distributed nature of data
 - Emphasis on the use of data

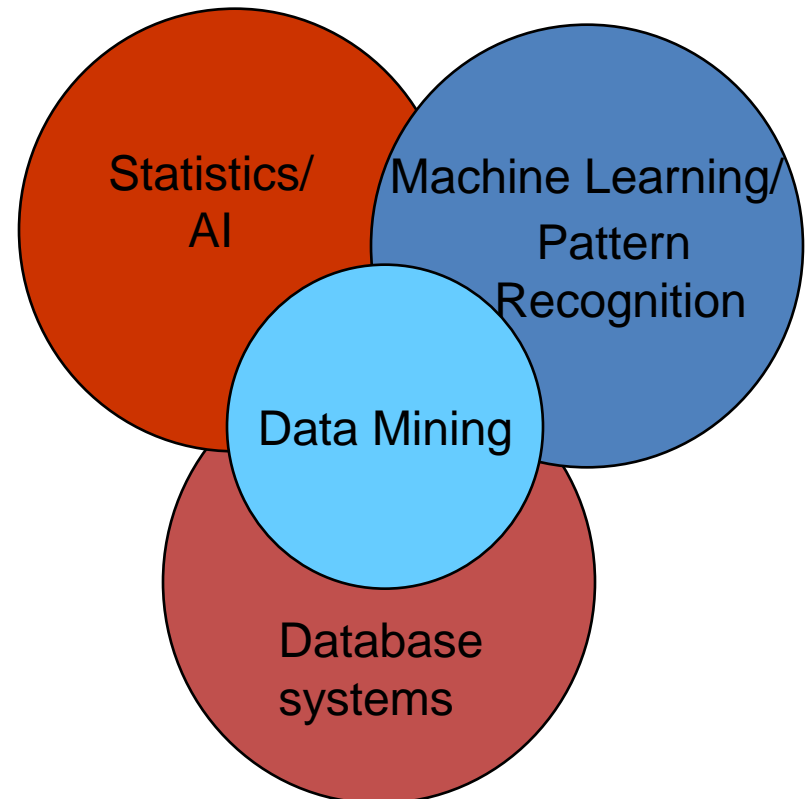

Cultures

- **Databases**: concentrate on large-scale (non-main-memory) data.
- **AI** (machine-learning): concentrate on complex methods, small data.
 - In today's world data is more important than algorithms
- **Statistics**: concentrate on models.

Models vs. Analytic Processing

- To a database person, data-mining is an extreme form of **analytic processing** – queries that examine large amounts of data.
 - Result is the query answer.
- To a statistician, data-mining is the inference of models.
 - Result is the parameters of the model.

(Way too Simple) Example

- Given a billion numbers, a DB person would compute their average and standard deviation.
- A statistician might fit the billion points to the best Gaussian distribution and report the mean and standard deviation *of that distribution*.

Data Mining: Confluence of Multiple Disciplines

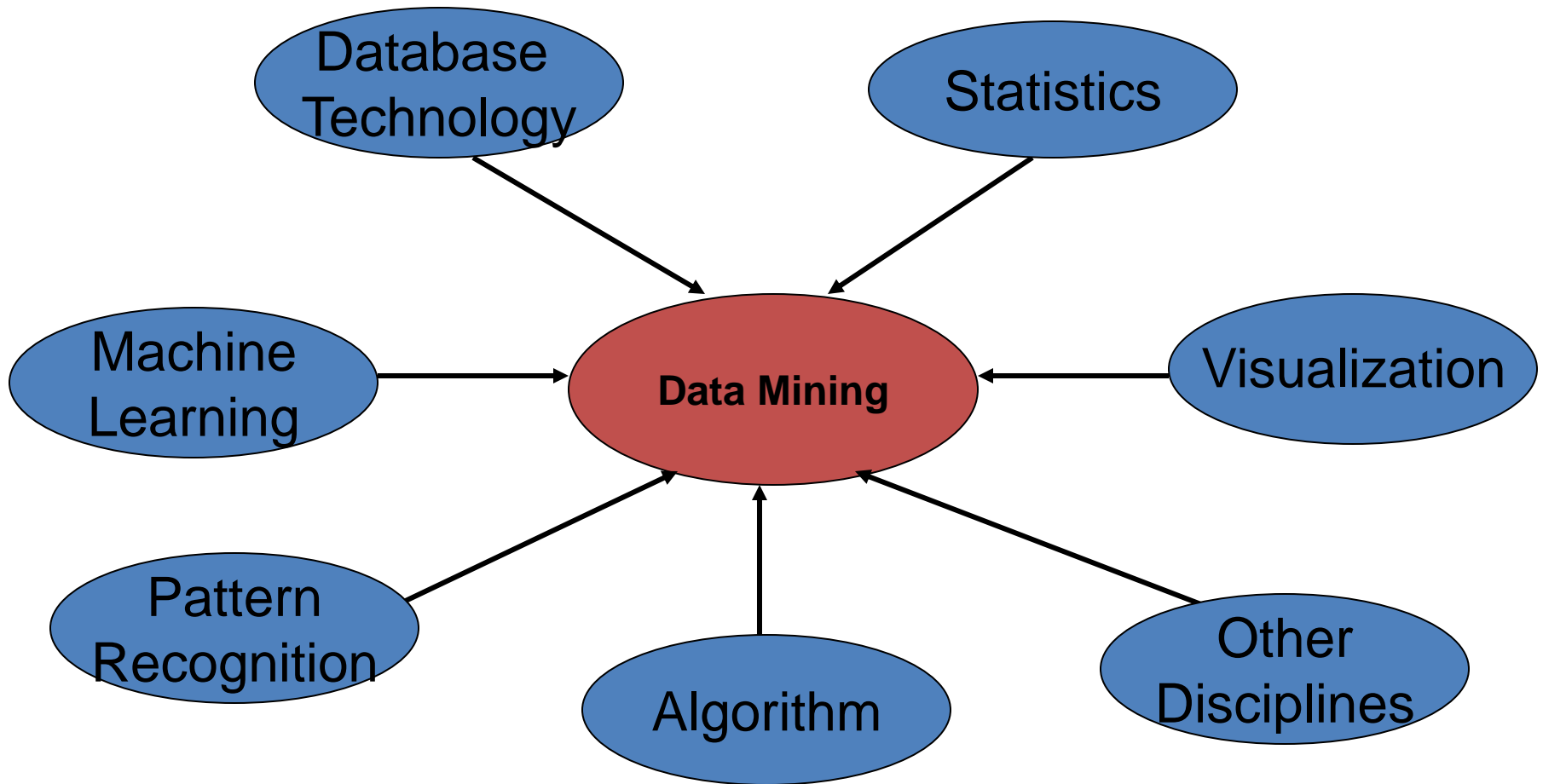

Data Mining: Confluence of Multiple Disciplines

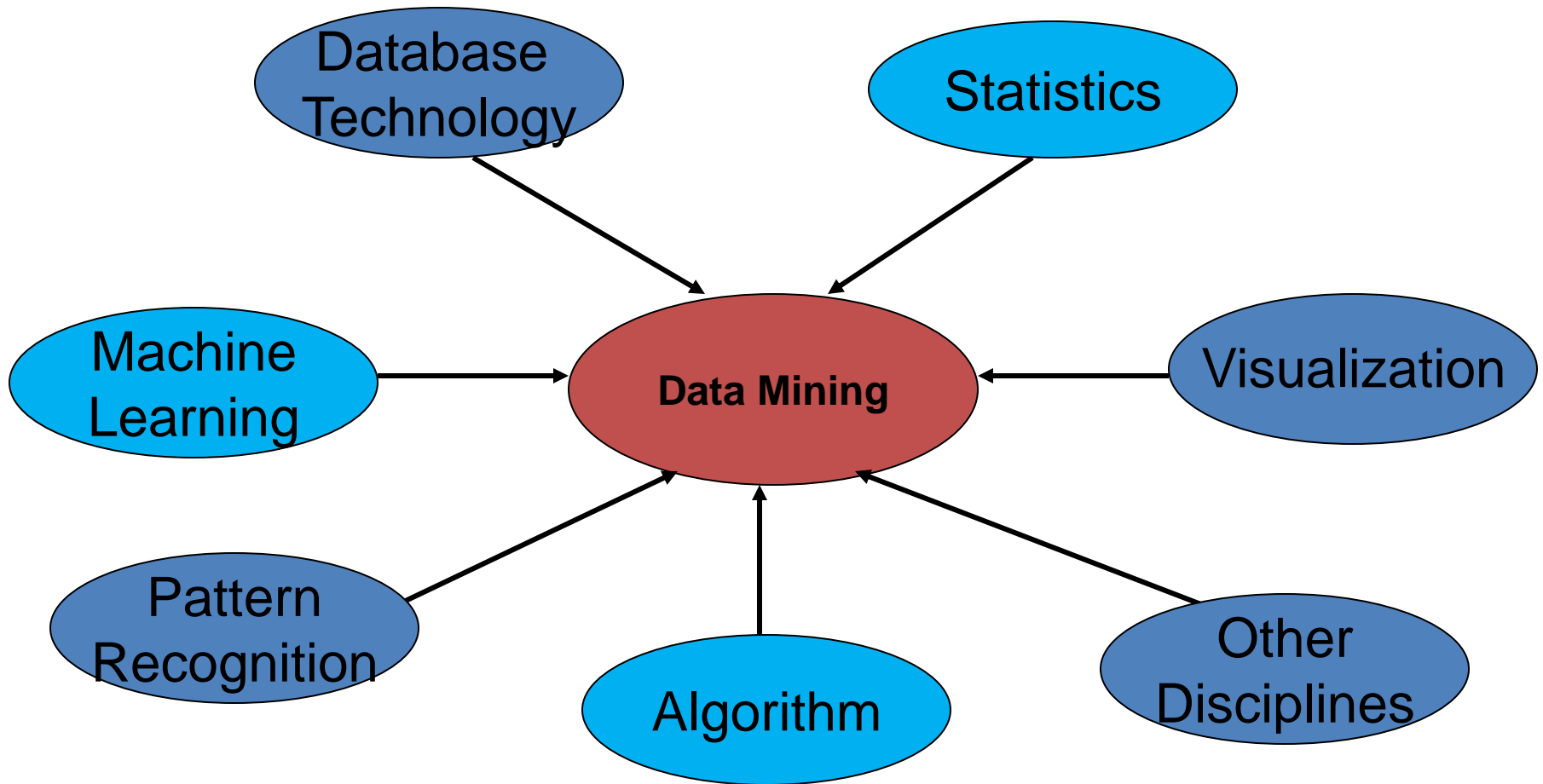

Data Mining: Confluence of Multiple Disciplines

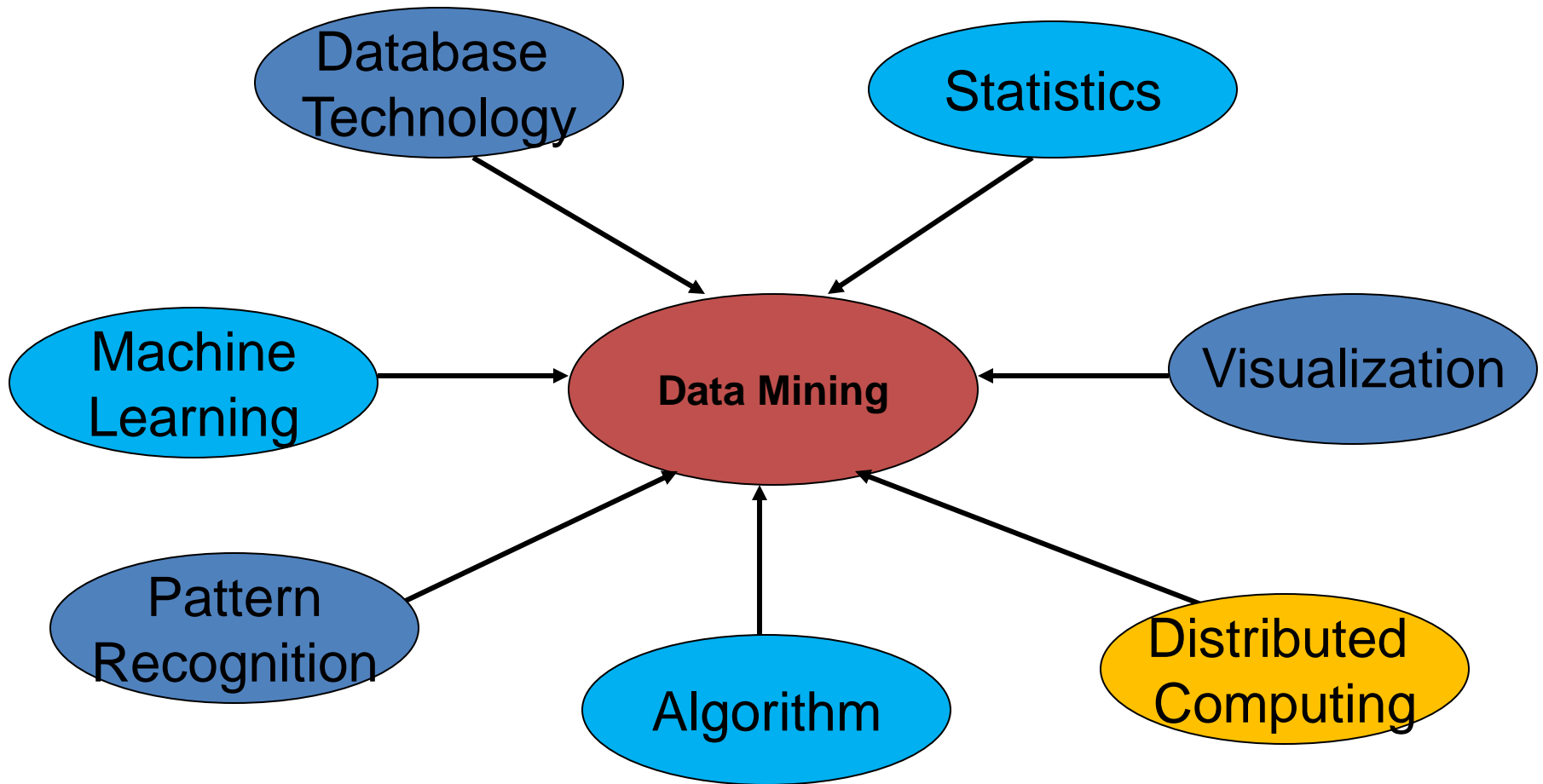

Single-node architecture

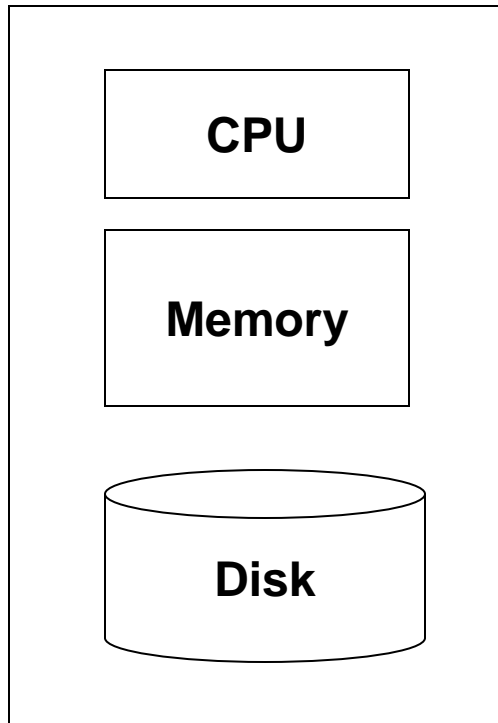

Machine Learning, Statistics

“Classical” Data Mining

Commodity Clusters

- Web data sets can be very large
 - Tens to hundreds of terabytes
 - Cannot mine on a single server
- Standard architecture emerging:
 - Cluster of commodity Linux nodes, Gigabit ethernet interconnect
 - Google GFS; Hadoop HDFS; Kosmix KFS
- Typical usage pattern
 - Huge files (100s of GB to TB)
 - Data is rarely updated in place
 - Reads and appends are common
- How to organize computations on this architecture?
 - [Map-Reduce](#) paradigm

Cluster Architecture

2-10 Gbps backbone between racks

1 Gbps between
any pair of nodes
in a rack

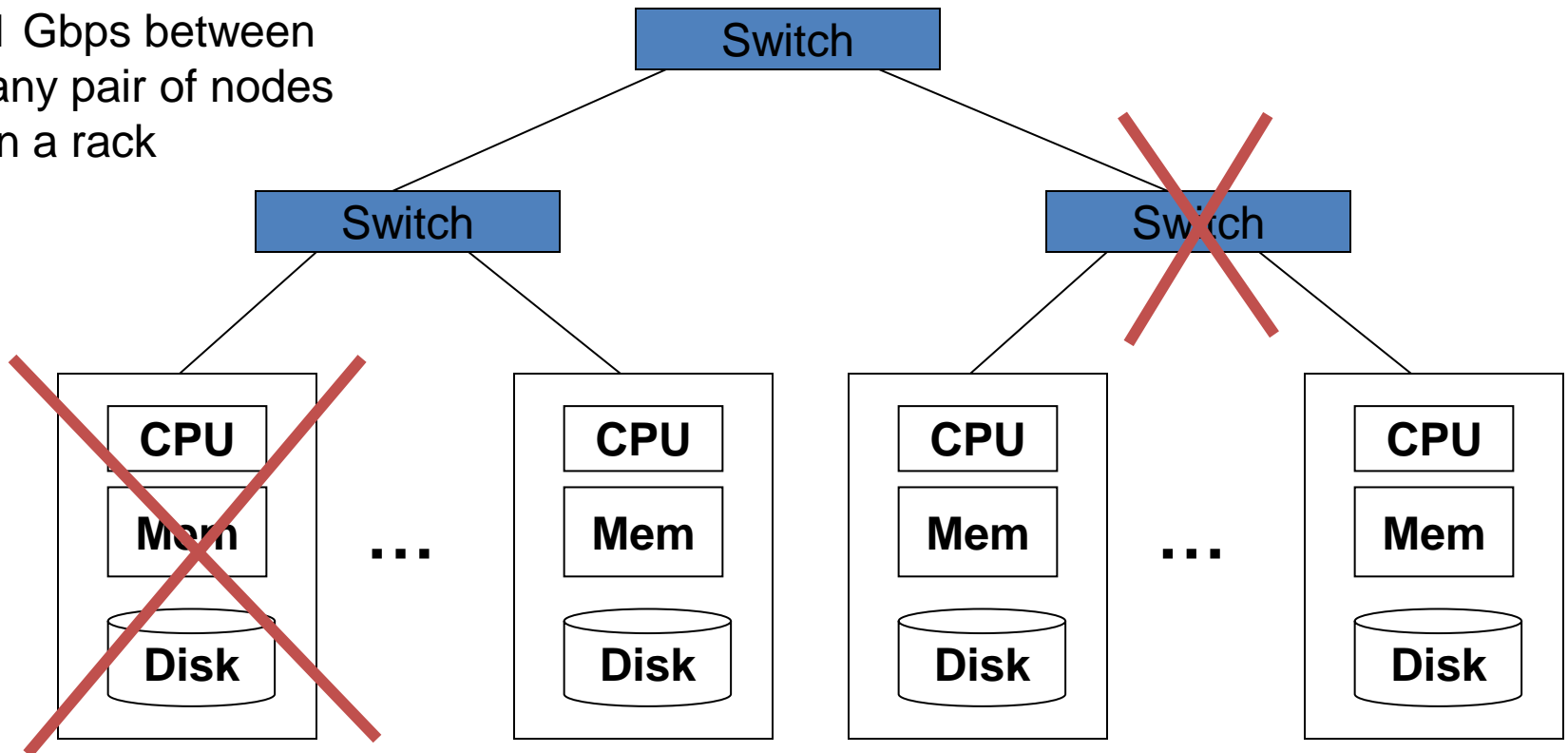

Each rack contains 16-64 nodes

Map-Reduce paradigm

- Map the data into key-value pairs
 - E.g., map a document to word-count pairs
- Group by key
 - Group all pairs of the same word, with lists of counts
- Reduce by aggregating
 - E.g. sum all the counts to produce the total count.