

DECREASE & CONQUER

Description:

Decrease & conquer is a general algorithm design strategy based on exploiting the relationship between a solution to a given instance of a problem and a solution to a smaller instance of the same problem. The exploitation can be either top-down (recursive) or bottom-up (non-recursive).

The major variations of decrease and conquer are

1. Decrease by a constant :(usually by 1):
 - a. insertion sort
 - b. graph traversal algorithms (DFS and BFS)
 - c. topological sorting
 - d. algorithms for generating permutations, subsets
2. Decrease by a constant factor (usually by half)
 - a. binary search and bisection method
3. Variable size decrease
 - a. Euclid's algorithm

Following diagram shows the major variations of decrease & conquer approach.

Decrease by a constant :(usually by 1):

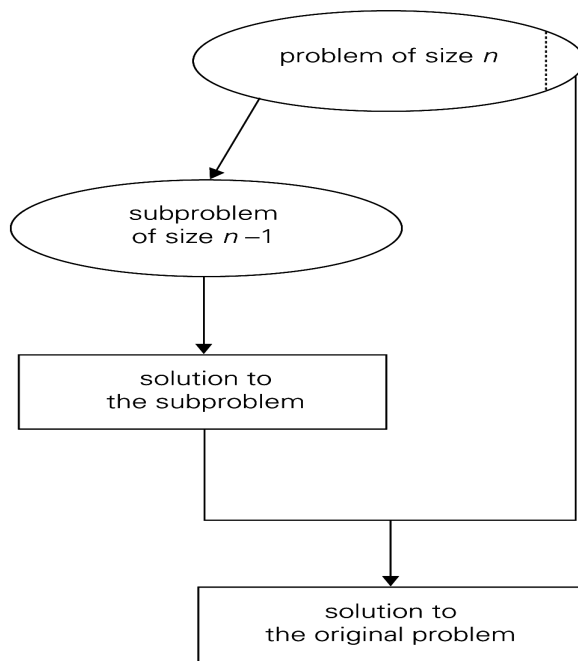

Decrease by a constant factor (usually by half)

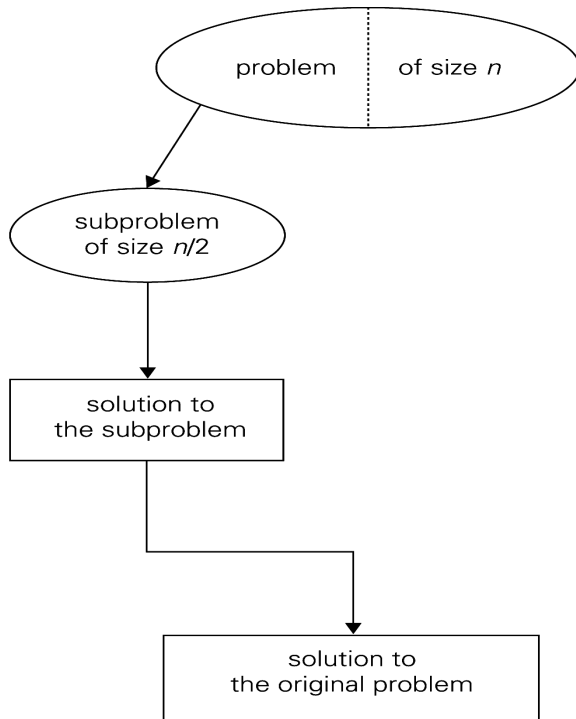

Insertion sort

Description:

Insertion sort is an application of decrease & conquer technique. It is a comparison based sort in which the sorted array is built on one entry at a time

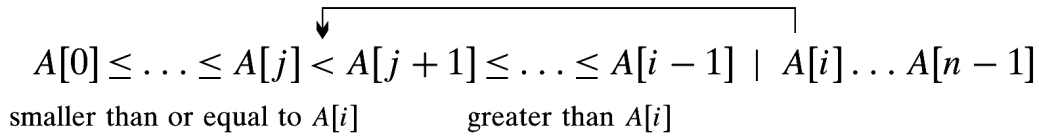

Algorithm:

ALGORITHM Insertionsort(A [0 ... n-1])

//sorts a given array by insertion sort

//i/p: Array A[0...n-1]

//o/p: sorted array A[0...n-1] in ascending order

for i ← 1 to n-1

V ← A[i]

j ← i-1

while j ≥ 0 AND A[j] > V do

A[j+1] ← A[j]

j ← j - 1

A[j + 1] ← V

Analysis:

- **Input size:** Array size, n
- **Basic operation:** key comparison
- Best, worst, average case exists
 - Best case: when input is a sorted array in ascending order:
 - Worst case: when input is a sorted array in descending order:
- Let $C_{\text{worst}}(n)$ be the number of key comparison in the worst case. Then

$$C_{\text{worst}}(n) = \sum_{i=1}^{n-1} \sum_{j=0}^{i-1} 1 = \sum_{i=1}^{n-1} i = \frac{(n-1)n}{2} \in \Theta(n^2).$$

- Let $C_{\text{best}}(n)$ be the number of key comparison in the best case. Then

$$C_{\text{best}}(n) = \sum_{i=1}^{n-1} 1 = n - 1 \in \Theta(n).$$

Example:

Sort the following list of elements using insertion sort:

89, 45, 68, 90, 29, 34, 17

89		45	68	90	29	34	17
45	89		68	90	29	34	17
45	68	89		90	29	34	17
45	68	89	90		29	34	17
29	45	68	89	90		34	17
29	34	45	68	89	90		17
17	29	34	45	68	89	90	

Advantages of insertion sort:

- Simple implementation. There are three variations
 - Left to right scan
 - Right to left scan
 - Binary insertion sort
- Efficient on small list of elements, on almost sorted list
- Running time is linear in best case
- Is a stable algorithm
- Is a in-place algorithm

Depth-first search (DFS) and Breadth-first search (BFS)

DFS and BFS are two graph traversing algorithms and follow decrease and conquer approach – decrease by one variation to traverse the graph

Some useful definition:

- **Tree edges:** edges used by DFS traversal to reach previously unvisited vertices
- **Back edges:** edges connecting vertices to previously visited vertices other than their immediate predecessor in the traversals
- **Cross edges:** edge that connects an unvisited vertex to vertex other than its immediate predecessor. (connects siblings)
- **DAG:** Directed acyclic graph

Depth-first search (DFS)

Description:

- DFS starts visiting vertices of a graph at an arbitrary vertex by marking it as visited.
- It visits graph's vertices by always moving away from last visited vertex to an unvisited one, backtracks if no adjacent unvisited vertex is available.
- Is a recursive algorithm, it uses a stack
- A vertex is pushed onto the stack when it's reached for the first time
- A vertex is popped off the stack when it becomes a dead end, i.e., when there is no adjacent unvisited vertex
- “Redraws” graph in tree-like fashion (with tree edges and back edges for undirected graph)

Algorithm:

ALGORITHM DFS (G)

//implements DFS traversal of a given graph

//i/p: Graph $G = \{ V, E \}$

//o/p: DFS tree

Mark each vertex in V with 0 as a mark of being “unvisited”

count $\leftarrow 0$

for each vertex v in V do

 if v is marked with 0

 dfs(v)

dfs(v)

count \leftarrow count + 1

mark v with count

for each vertex w in V adjacent to v do

 if w is marked with 0

 dfs(w)

Example:

Starting at vertex A traverse the following graph using DFS traversal method:

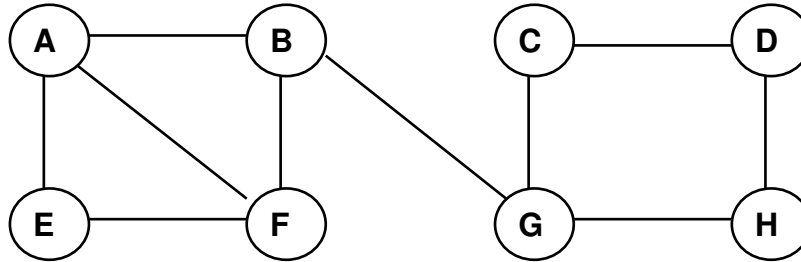

Solution:

Step	Graph	Remarks
1		Insert A into stack A(1)
2		Insert B into stack B (2) A(1)
3		Insert F into stack F (3) B (2) A(1)
4		Insert E into stack E (4) F (3) B (2) A(1)
5	NO unvisited adjacent vertex for E, backtrack	Delete E from stack E (4, 1) F (3) B (2) A(1)

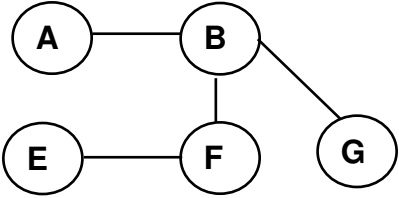
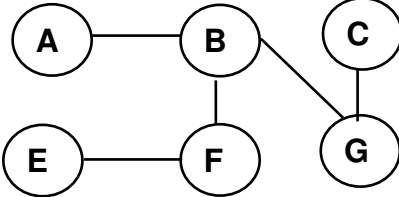
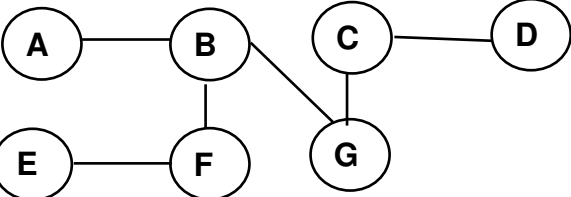
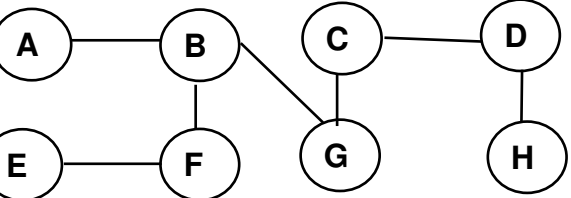
6	NO unvisited adjacent vertex for F, backtrack	Delete F from stack E (4, 1) F (3, 2) B (2) A(1)
7		Insert G into stack E (4, 1) F (3, 2) G (5) B (2) A(1)
8		Insert C into stack E (4, 1) C (6) F (3, 2) G (5) B (2) A(1)
9		Insert D into stack D (7) E (4, 1) C (6) F (3, 2) G (5) B (2) A(1)
10		Insert H into stack H (8) D (7) E (4, 1) C (6) F (3, 2) G (5) B (2) A(1)
11	NO unvisited adjacent vertex for H, backtrack	Delete H from stack H (8, 3) D (7) E (4, 1) C (6) F (3, 2) G (5) B (2) A(1)

12	NO unvisited adjacent vertex for D, backtrack	Delete D from stack H (8, 3) D (7, 4) E (4, 1) C (6) F (3, 2) G (5) B (2) A(1)
13	NO unvisited adjacent vertex for C, backtrack	Delete C from stack H (8, 3) D (7, 4) E (4, 1) C (6, 5) F (3, 2) G (5) B (2) A(1)
14	NO unvisited adjacent vertex for G, backtrack	Delete G from stack H (8, 3) D (7, 4) E (4, 1) C (6, 5) F (3, 2) G (5, 6) B (2) A(1)
15	NO unvisited adjacent vertex for B, backtrack	Delete B from stack H (8, 3) D (7, 4) E (4, 1) C (6, 5) F (3, 2) G (5, 6) B (2, 7) A(1)
16	NO unvisited adjacent vertex for A, backtrack	Delete A from stack H (8, 3) D (7, 4) E (4, 1) C (6, 5) F (3, 2) G (5, 6) B (2, 7) A(1, 8)
	Stack becomes empty. Algorithm stops as all the nodes in the given graph are visited	

The DFS tree is as follows: (dotted lines are back edges)

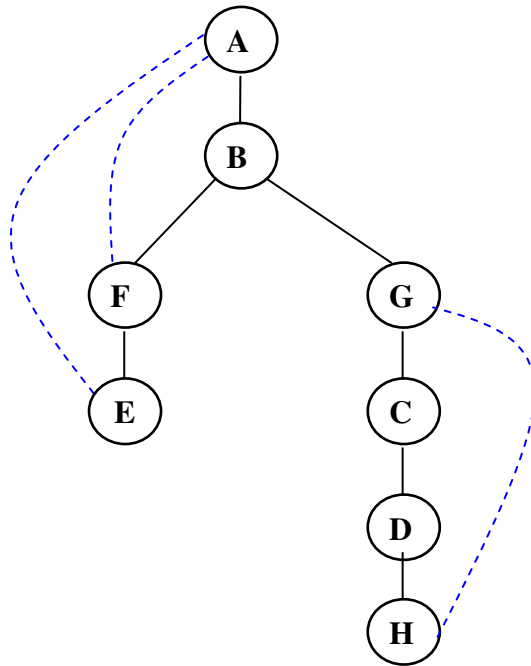

Applications of DFS:

- The two orderings are advantageous for various applications like topological sorting, etc
- To check connectivity of a graph (number of times stack becomes empty tells the number of components in the graph)
- To check if a graph is acyclic. (no back edges indicates no cycle)
- To find articulation point in a graph

Efficiency:

- Depends on the graph representation:
 - Adjacency matrix : $\Theta(n^2)$
 - Adjacency list: $\Theta(n + e)$

Breadth-first search (BFS)

Description:

- BFS starts visiting vertices of a graph at an arbitrary vertex by marking it as visited.
- It visits graph's vertices by across to all the neighbors of the last visited vertex
- Instead of a stack, BFS uses a queue
- Similar to level-by-level tree traversal
- "Redraws" graph in tree-like fashion (with tree edges and cross edges for undirected graph)

Algorithm:

ALGORITHM BFS (G)

//implements BFS traversal of a given graph

//i/p: Graph $G = \{ V, E \}$

//o/p: BFS tree/forest

Mark each vertex in V with 0 as a mark of being "unvisited"

count $\leftarrow 0$

for each vertex v in V do

 if v is marked with 0

 bfs(v)

bfs(v)

count \leftarrow count + 1

mark v with count and initialize a queue with v

while the queue is NOT empty do

 for each vertex w in V adjacent to front's vertex v do

 if w is marked with 0

 count \leftarrow count + 1

 mark w with count

 add w to the queue

 remove vertex v from the front of the queue

Example:

Starting at vertex A traverse the following graph using BFS traversal method:

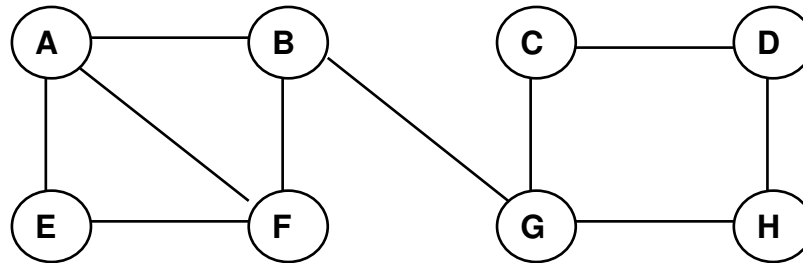

Solution:

Step	Graph	Remarks
1		Insert A into queue A(1)
2		Insert B, E into queue A(1), B (2), E(3) B (2), E(3)
3		Insert F, G into queue B(2), E(3), F(3), G(4) E(3), F(3), G(4)
4	NO unvisited adjacent vertex for E, backtrack	Delete E from queue F(3), G(4)
5	NO unvisited adjacent vertex for F, backtrack	Delete F from queue G(4)
6		Insert C, H into queue G(4), C(5), H(6) C(5), H(6)

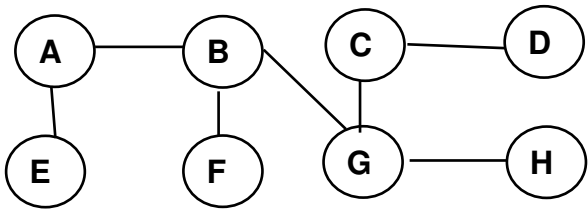
7		Insert D into queue C(5), H(6), D(7) H(6), D(7)
8	NO unvisited adjacent vertex for H, backtrack	Delete H from queue D(7)
9	NO unvisited adjacent vertex for D, backtrack	Delete D from queue
	Queue becomes empty. Algorithm stops as all the nodes in the given graph are visited	

The BFS tree is as follows: (dotted lines are cross edges)

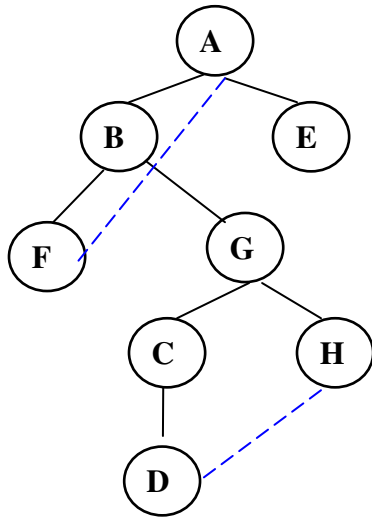

Applications of BFS:

- To check connectivity of a graph (number of times queue becomes empty tells the number of components in the graph)
- To check if a graph is acyclic. (no cross edges indicates no cycle)
- To find minimum edge path in a graph

Efficiency:

- Depends on the graph representation:
 - Array : $\Theta(n^2)$
 - List: $\Theta(n + e)$

Difference between DFS & BFS:

	DFS	BFS
Data structure	Stack	Queue
No. of vertex orderings	2 orderings	1 ordering
Edge types	Tree edge Back edge	Tree edge Cross edge
Applications	Connectivity Acyclicity Articulation points	Connectivity Acyclicity Minimum edge paths
Efficiency for adjacency matrix	$\Theta(n^2)$	$\Theta(n^2)$
Efficiency for adjacency lists	$\Theta(n + e)$	$\Theta(n + e)$

Topological Sorting

Description:

Topological sorting is a sorting method to list the vertices of the graph in such an order that for every edge in the graph, the vertex where the edge starts is listed before the vertex where the edge ends.

NOTE:

There is no solution for topological sorting if there is a cycle in the digraph .
[MUST be a DAG]

Topological sorting problem can be solved by using

1. DFS method
2. Source removal method

DFS Method:

- Perform DFS traversal and note the order in which vertices become dead ends (popped order)
- Reverse the order, yield the topological sorting.

Example:

Apply DFS – based algorithm to solve the topological sorting problem for the given graph:

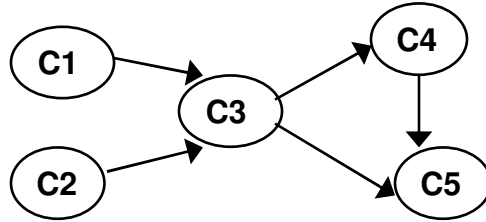

Step	Graph	Remarks
1		Insert C1 into stack C1(1)
2		Insert C2 into stack C2 (2) C1(1)
3		Insert C4 into stack C4 (3) C2 (2) C1(1)
4		Insert C5 into stack C5 (4) C4 (3) C2 (2) C1(1)

5	NO unvisited adjacent vertex for C5, backtrack	Delete C5 from stack C5 (4, 1) C4 (3) C2 (2) C1(1)
6	NO unvisited adjacent vertex for C4, backtrack	Delete C4 from stack C5 (4, 1) C4 (3, 2) C2 (2) C1(1)
7	NO unvisited adjacent vertex for C3, backtrack	Delete C3 from stack C5 (4, 1) C4 (3,2) C2 (2, 3) C1(1)
8	NO unvisited adjacent vertex for C1, backtrack	Delete C1 from stack C5 (4, 1) C4 (3,2) C2 (2, 3) C1(1, 4)
Stack becomes empty, but there is a node which is unvisited, therefore start the DFS again from arbitrarily selecting a unvisited node as source		
9		Insert C2 into stack C5 (4, 1) C4 (3,2) C2 (2, 3) C1(1, 4) C2(5)
10	NO unvisited adjacent vertex for C2, backtrack	Delete C2 from stack C5 (4, 1) C4 (3,2) C2 (2, 3) C1(1, 4) C2(5, 5)
Stack becomes empty, NO unvisited node left, therefore algorithm stops. The popping – off order is: C5, C4, C3, C1, C2, Topologically sorted list (reverse of pop order): C2, C1 → C3 → C4 → C5		

Source removal method:

- Purely based on decrease & conquer
- Repeatedly identify in a remaining digraph a source, which is a vertex with no incoming edges
- Delete it along with all the edges outgoing from it.

Example:

Apply Source removal – based algorithm to solve the topological sorting problem for the given graph:

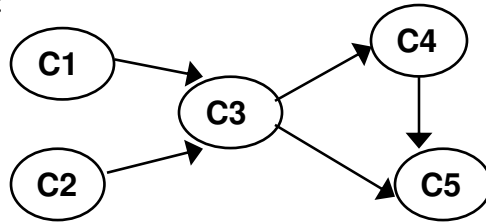

Solution:

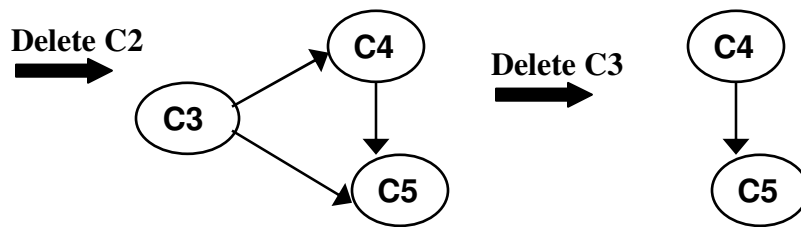
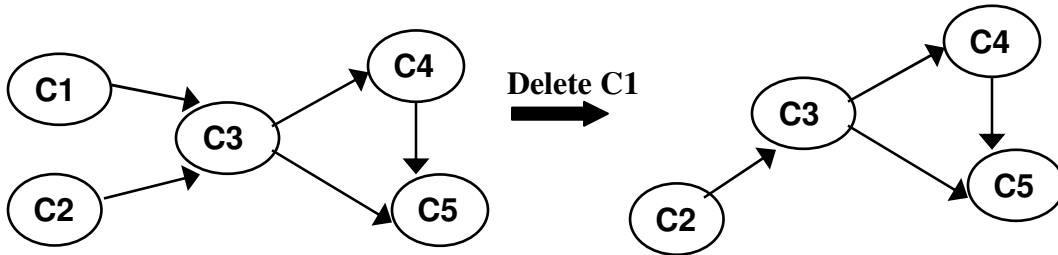

Delete C3

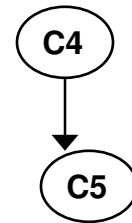

Delete C4



Delete C5

The topological order is C1, C2, C3, C4, C5